

390 **0%**
MERCURY

SR1130SW
Watch Battery
Swiss Made

Technical Data Sheet

Specifications

Chemical system	Zinc / Monovalent Silver Oxide, low drain
Nominal Voltage	1,55 V
Capacity	60 mAh, Discharge over 15 kΩ at 20°C to 0,9 V
Operating Temperature*	-10°C – 60°C
Self Discharge	Less than 5% per year at 20°C
Weight	~1,16 g

Dimensions

(according IEC 60086-3)

Diameter	11,60 mm (0,457")
Height	3,05 mm (0,120")

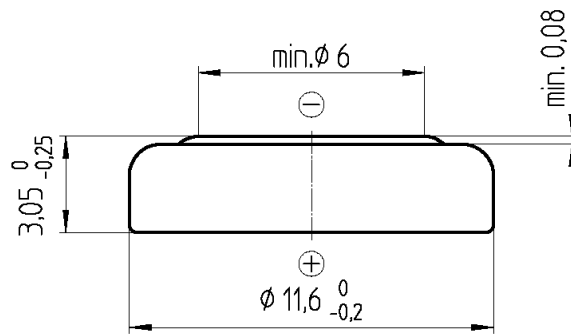

Discharge Curve

Constant Load	15 kΩ
Starting Drain	104 μA
Temperature	20°C

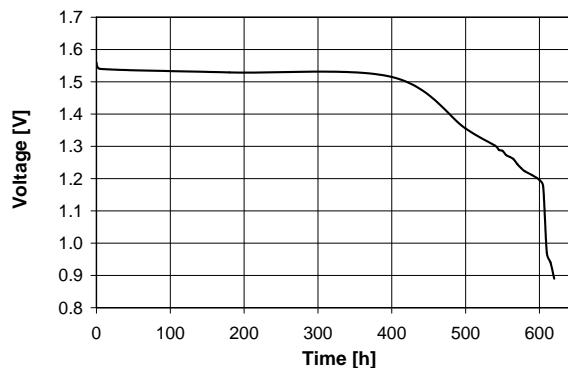

Information and contents in this data sheet are for reference purpose only. They do not constitute any warranty or representation and are subject to change without notice. For most current information and further details, please contact your Renata representative. For safety related information please consult the PSDS document related to that product or product family.

*Condensing humidity not allowed

Rev. 390MF.06 2017/07