

# 二酸化マンガン・リチウム電池

## Coin Type Manganese Dioxide Lithium Battery

# CR2032

### ■外形寸法 Dimensions(mm)

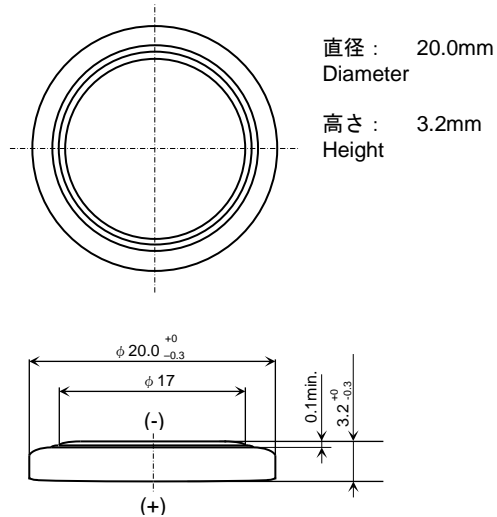

### ■定格 Specifications

公称電圧 Nominal Voltage	3V
公称容量 (終止電圧 2.0V) Nominal Capacity (2.0V cutoff)	220mAh
標準放電電流値 Standard Discharge Current	0.2mA
標準質量 Weight	3.2g

### 用途 Applications

- 時計 ● カードラジオ ● リモートコントローラー
- 電子ゲーム・玩具
- SRAMやリアルタイムクロック等メモリーバックアップ
- Electronic Watch or Clock ● Card Radio
- Remote Controller ● Electric Game, Toy
- Memory Back-up Power Source for SRAM or Real Time Clock (RTC)

### ■放電特性 Discharge Characteristics

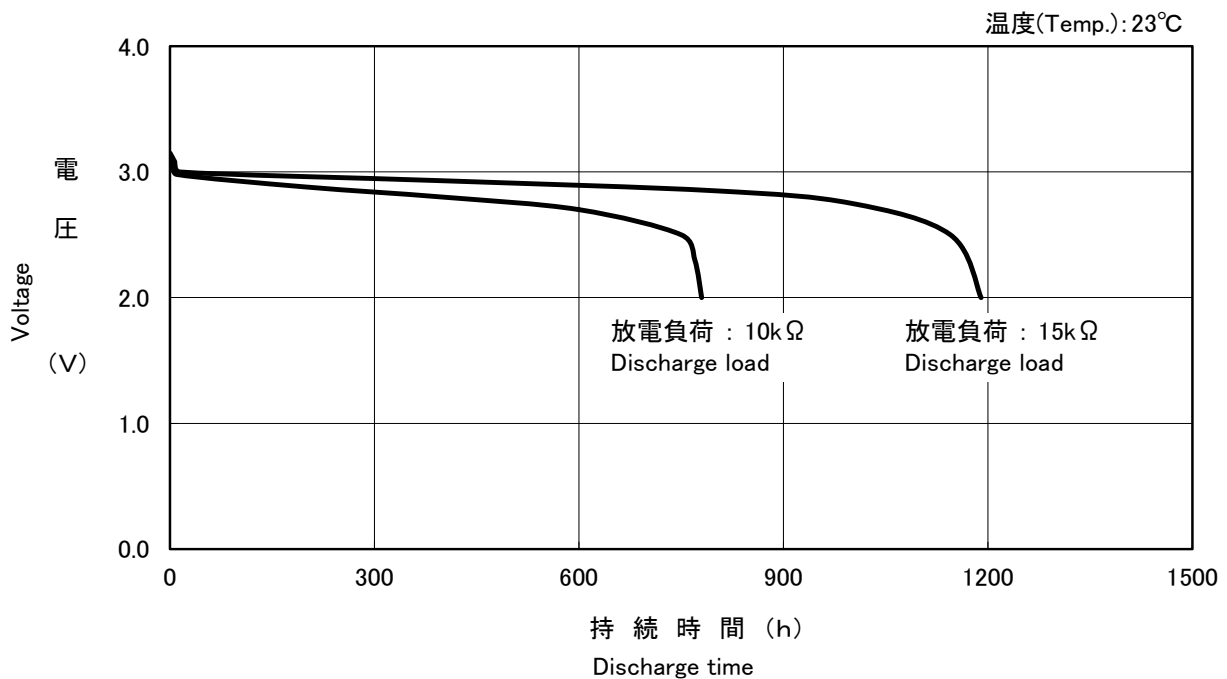

■放電負荷特性

Discharge Characteristics on Load

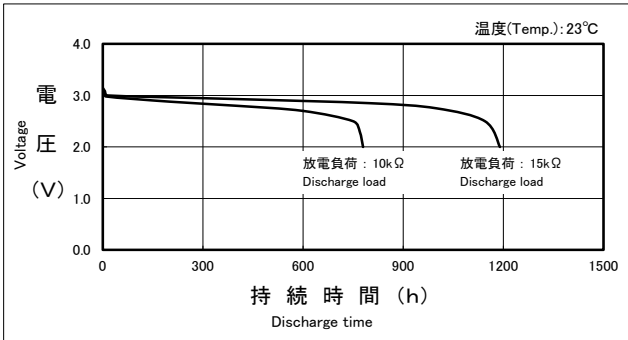

■放電温度特性

Discharge Characteristics on Temperature

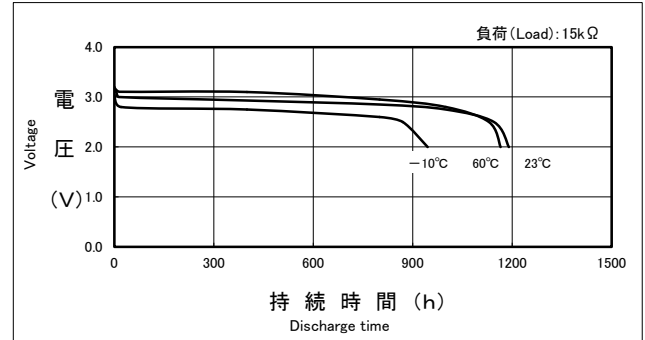

■放電負荷と作動電圧 (放電深度 40%時の電圧)

Discharge Load vs. Operation Voltage (Discharge depth 40%)

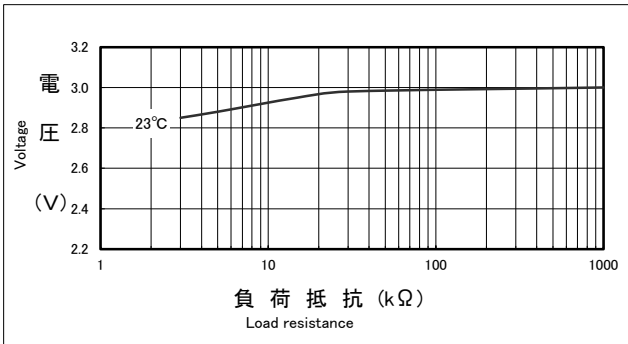

■放電負荷と電気容量

Discharge Load vs. Discharge Capacity

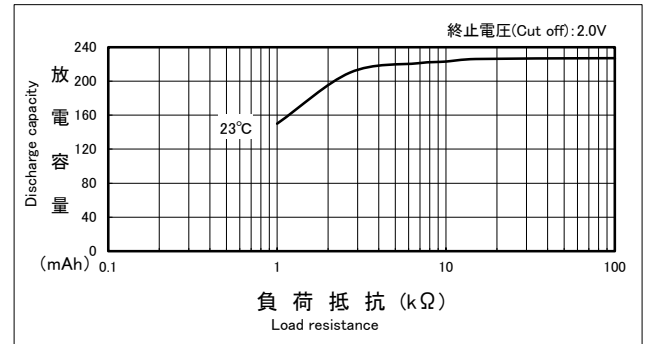

■パルス放電特性 (放電深度 40%時のパルス電圧)

Discharge Characteristics on Pulse Load (Discharge depth 40%)

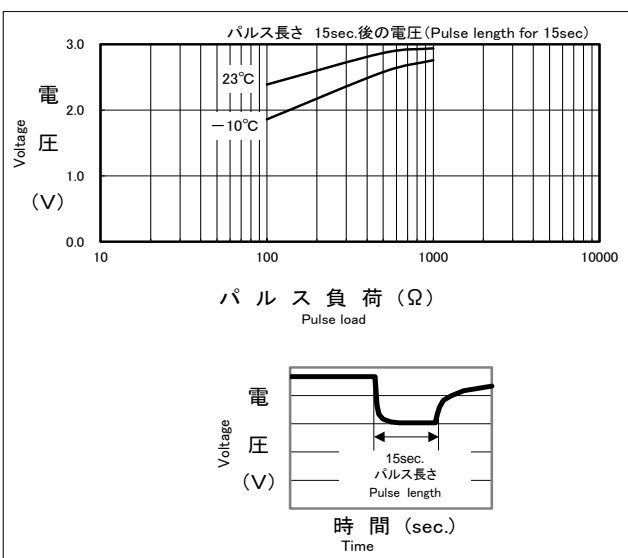

■保存特性

Storage Characteristics

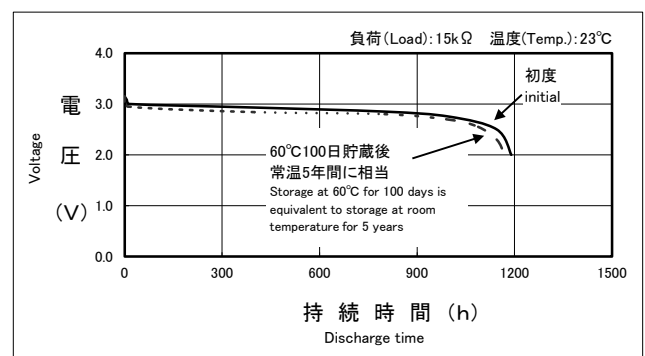

\*記載のデータ及び数値は、参考値であり保証値ではありません。

\*Data is not guaranteed, and is provided for reference purposes only.