

# 二酸化マンガン・リチウム電池

## Coin Type Manganese Dioxide Lithium Battery

# CR1216

### ■外形寸法 Dimensions(mm)

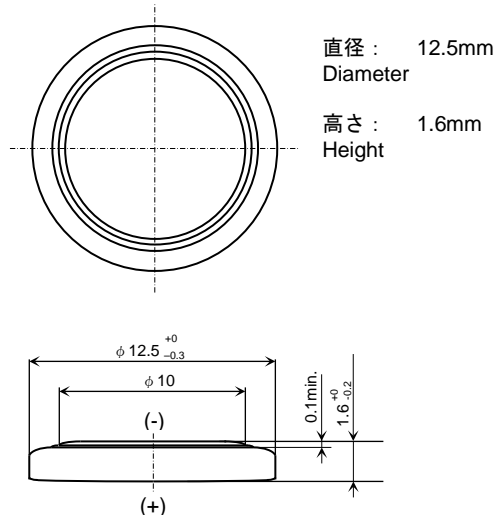

### ■定格 Specifications

公称電圧 Nominal Voltage	3V
公称容量 (終止電圧 2.0V) Nominal Capacity (2.0V cutoff)	30mAh
標準放電電流値 Standard Discharge Current	0.1mA
標準質量 Weight	0.7g

### 用途 Applications

- 時計
- 電子手帳・電卓
- SRAMやリアルタイムクロック等メモリーバックアップ
- Electronic Watch or Clock
- Electronic Calculator
- Memory Back-up Power Source for SRAM or Real Time Clock (RTC)

### ■放電特性 Discharge Characteristics

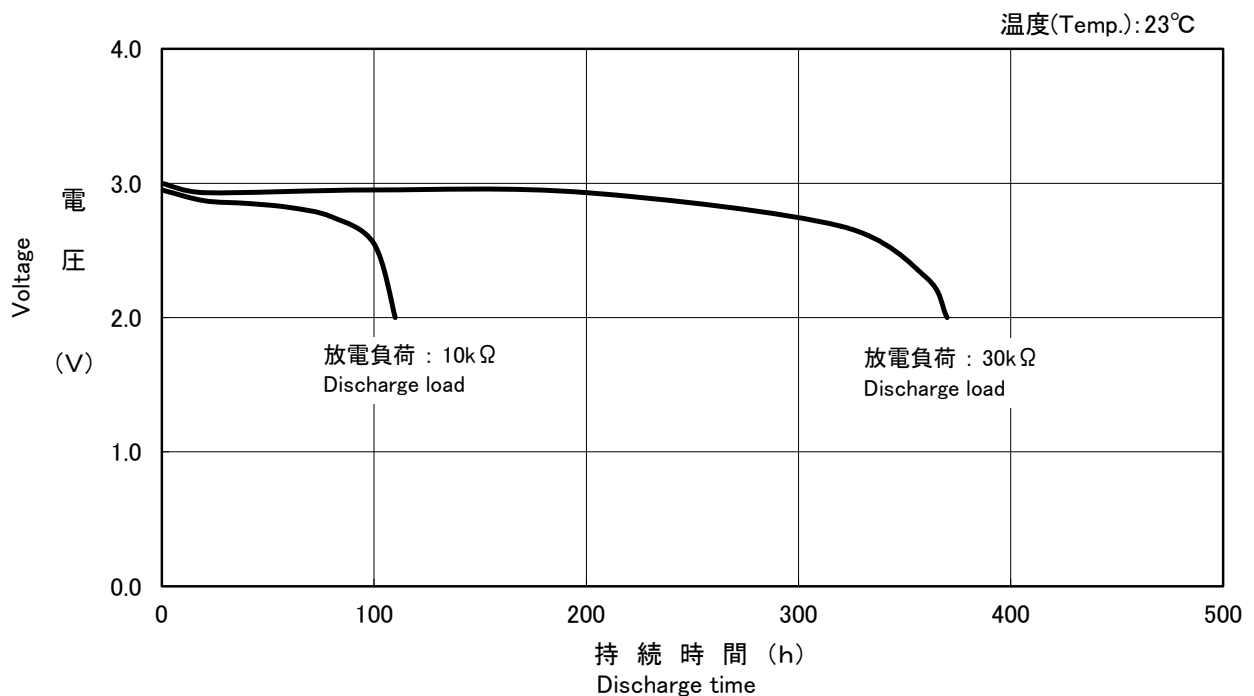

■放電負荷特性

Discharge Characteristics on Load

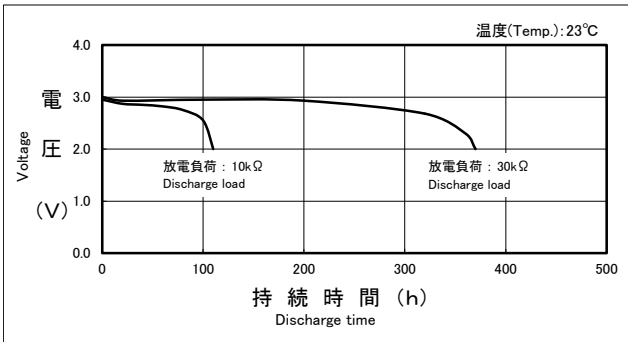

■放電温度特性

Discharge Characteristics on Temperature

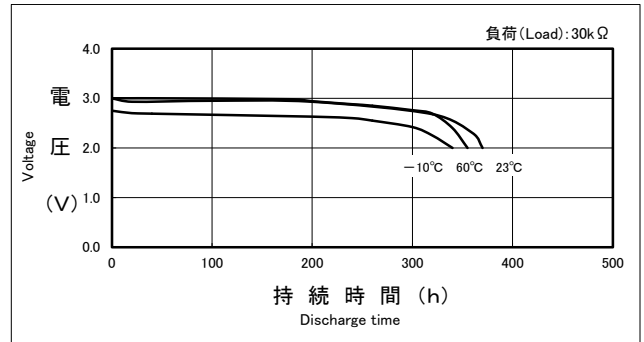

■放電負荷と作動電圧（放電深度 40%時の電圧）

Discharge Load vs. Operation Voltage (Discharge depth 40%)

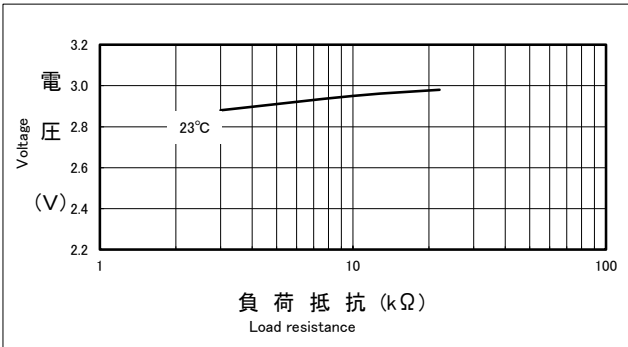

■放電負荷と電気容量

Discharge Load vs. Discharge Capacity

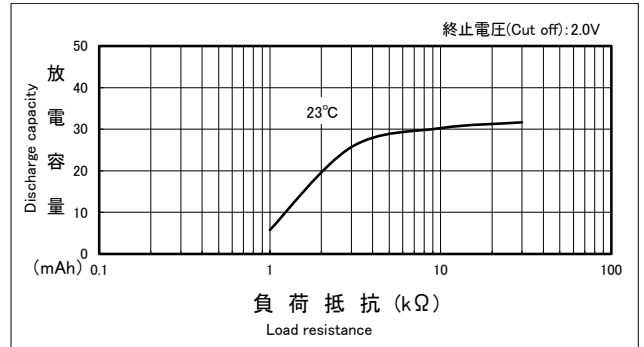

■パルス放電特性（放電深度 40%時のパルス電圧）

Discharge Characteristics on Pulse Load (Discharge depth 40%)

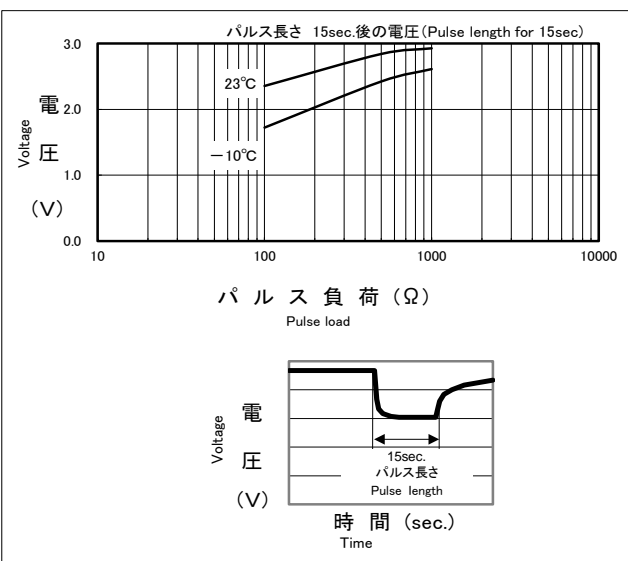

■保存特性

Storage Characteristics

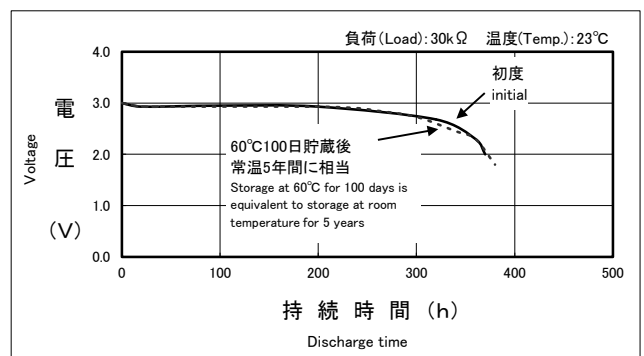

\*記載のデータ及び数値は、参考値であり保証値ではありません。

\*Data is not guaranteed, and is provided for reference purposes only.