

二酸化マンガン・リチウム電池 CR2430

Lithium Manganese Dioxide Battery

外形寸法 Dimensions (mm)

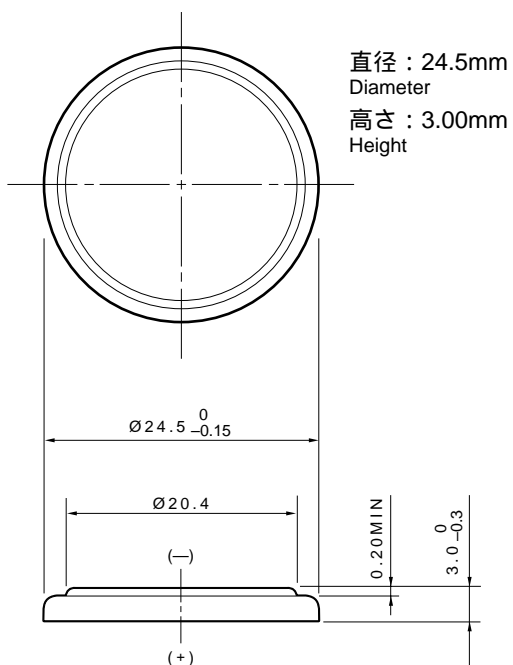

定格 Specifications

公称電圧 Nominal Voltage	3V
公称容量 (終止電圧2.5V) Nominal Capacity (2.5V cutoff)	280mAh
推奨負荷電流値 (標準) Recommended Continuous Drain	0.4mA
推奨負荷電流値 (パルス) Recommended Pulse Drain	21mA
標準質量 Weight	4.6g
用途 Applications SRAMやリアルタイムクロック等メモリーバックアップ Memory Back-up Power Source for SRAM or Real Time Clock (RTC)	

放電特性 Discharge Characteristics

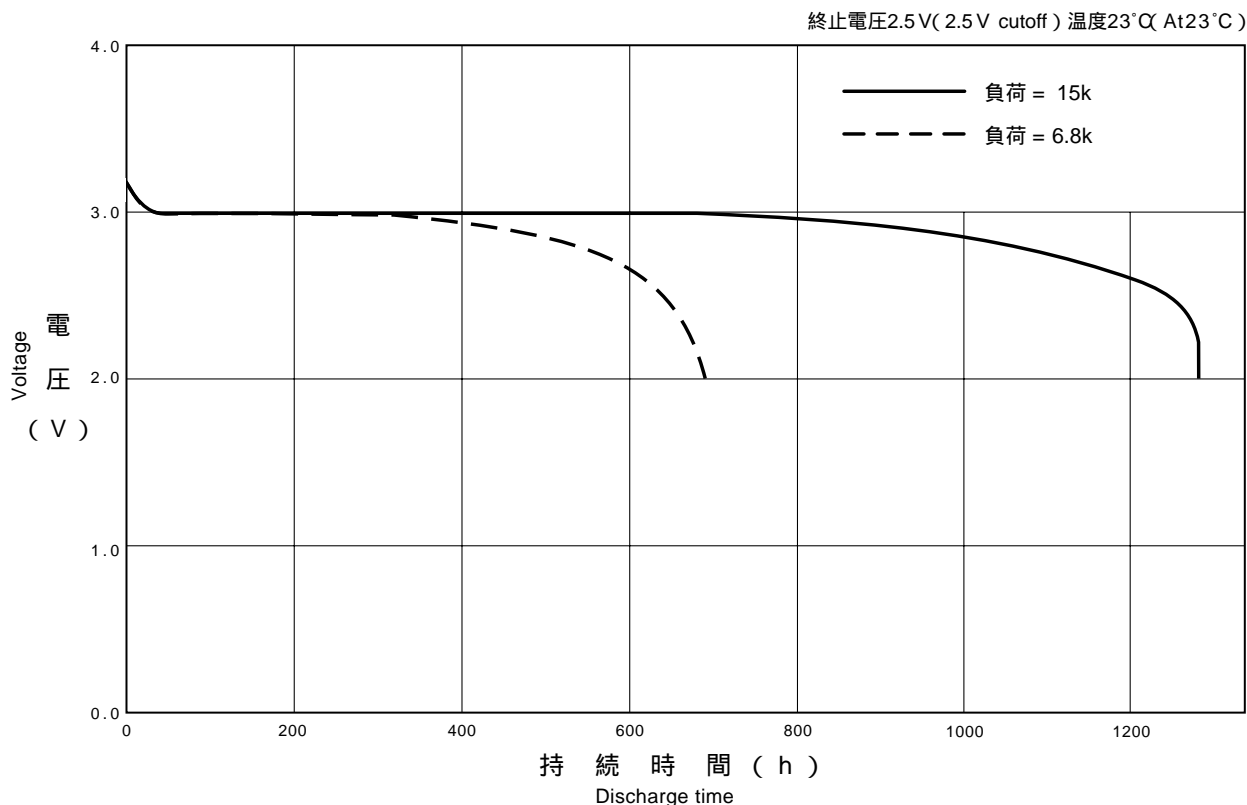

放電負荷特性

Discharge Characteristics on Load

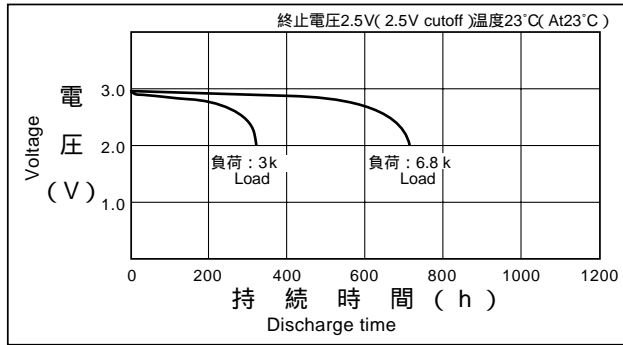

放電温度特性

Discharge Characteristics on Temperature

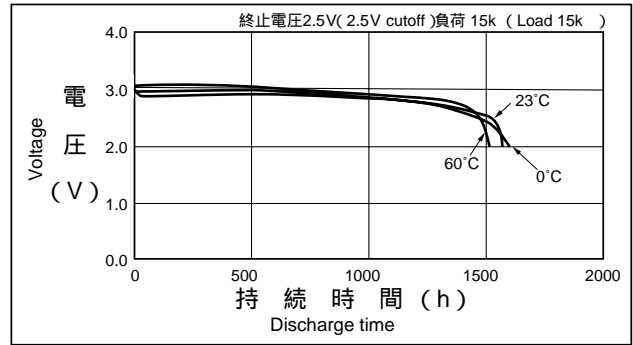

放電負荷と作動電圧(放電深度40%時の電圧)

Discharge Load vs. Operation Voltage (Discharge depth 40%)

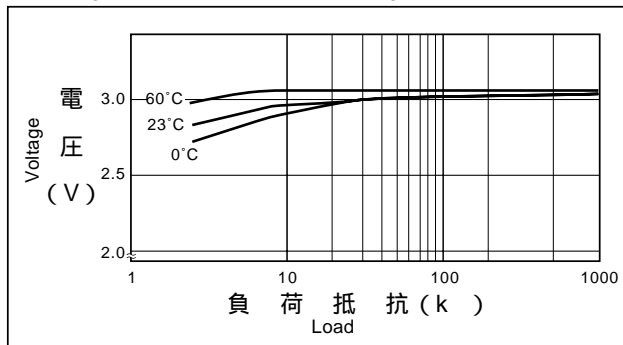

放電負荷と電気容量

Discharge Load vs. Discharge Capacity

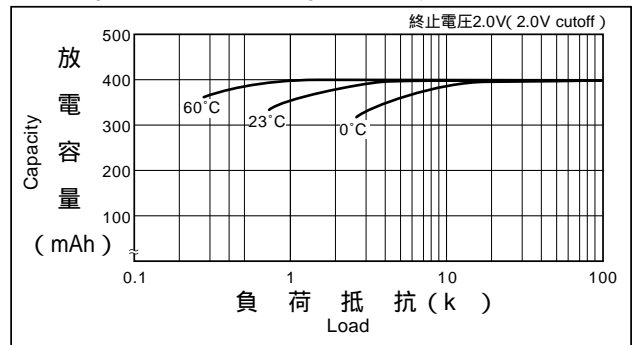

パルス放電特性(放電深度40%時のパルス電圧)

Discharge Characteristics on Pulse Load (Discharge depth 40%)

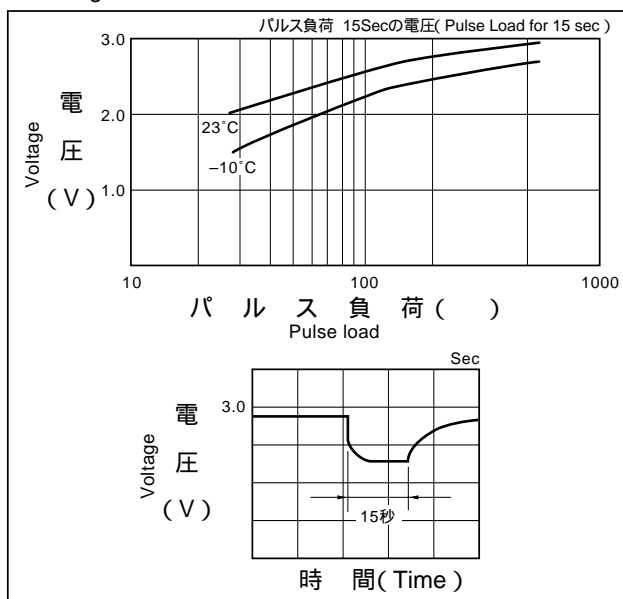

保存特性

Storage Characteristics

