

# 二酸化マンガン・リチウム電池

## Lithium Manganese Dioxide Battery

# CR2032

### 外形寸法 Dimensions (mm)

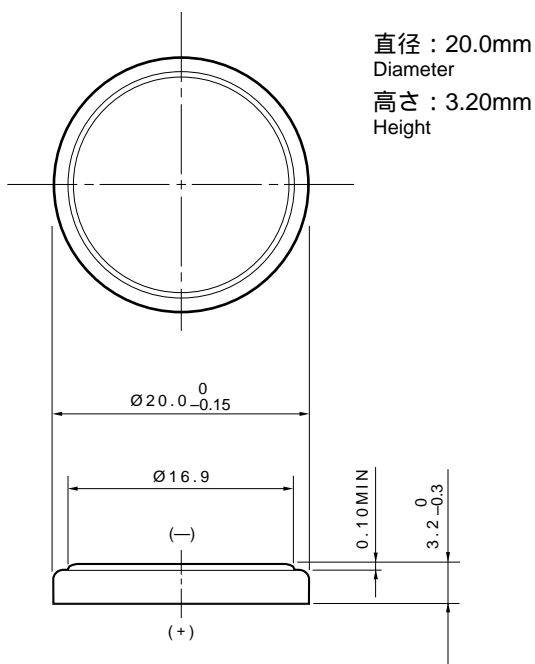

### 定格 Specifications

公称電圧 Nominal Voltage	3V
公称容量 (終止電圧2.5V) Nominal Capacity (2.5V cutoff)	220mAh
推奨負荷電流値 (標準) Recommended Continuous Drain	0.3mA
推奨負荷電流値 (パルス) Recommended Pulse Drain	12mA
標準質量 Weight	3.2g
<b>用途 Applications</b> 時計 カードラジオ リモートコントローラー 電子ゲーム・玩具 SRAMやリアルタイムクロック等メモリーバックアップ Electronic Watch or Clock Card Radio Remote Controller Electronic Game, Toy Memory Back-up Power Source for SRAM or Real Time Clock (RTC)	

### 放電特性 Discharge Characteristics

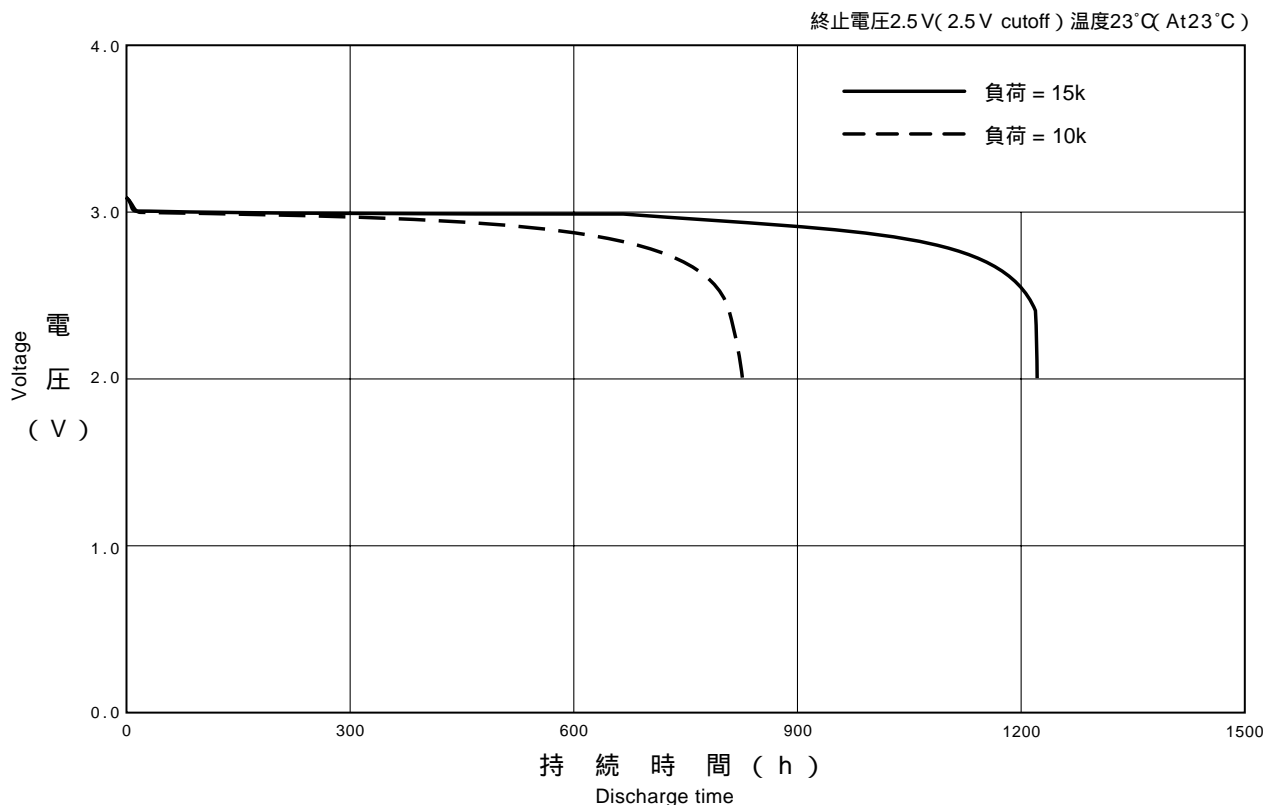

## 放電負荷特性

Discharge Characteristics on Load

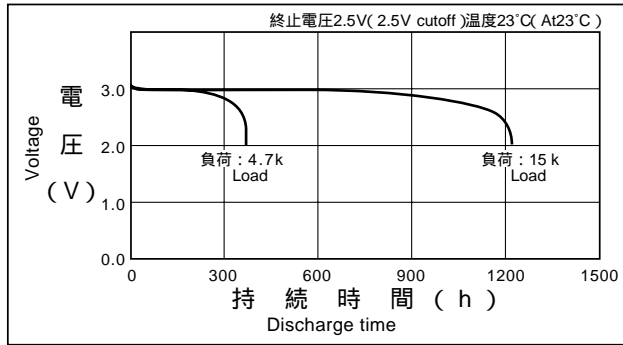

## 放電温度特性

Discharge Characteristics on Temperature

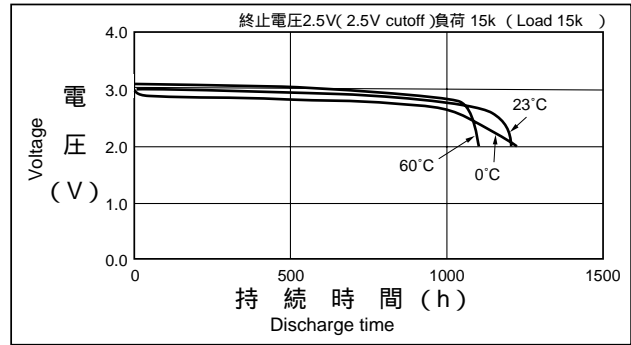

## 放電負荷と作動電圧(放電深度40%時の電圧)

Discharge Load vs. Operation Voltage (Discharge depth 40%)

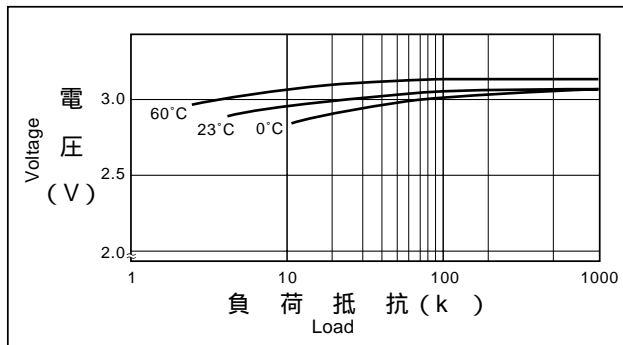

## 放電負荷と電気容量

Discharge Load vs. Discharge Capacity

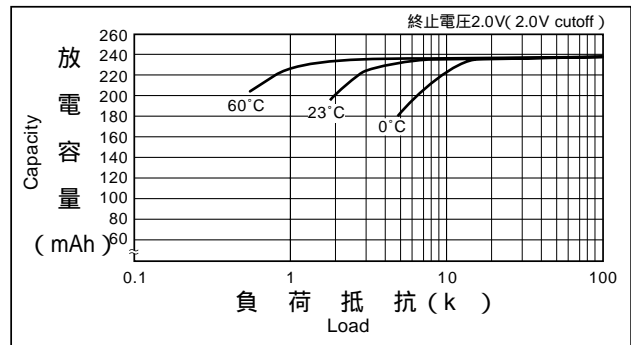

## パルス放電特性(放電深度40%時のパルス電圧)

Discharge Characteristics on Pulse Load (Discharge depth 40%)

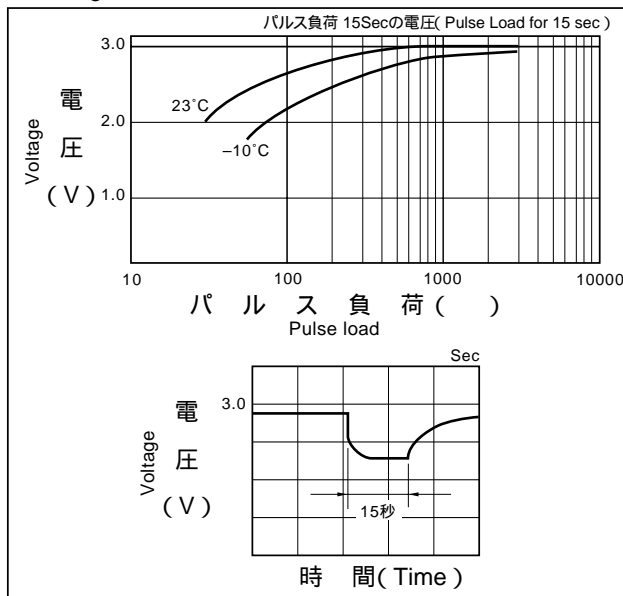

## 保存特性

Storage Characteristics

