

# 二酸化マンガン・リチウム電池

## Lithium Manganese Dioxide Battery

# CR1216

### 外形寸法 Dimensions (mm)

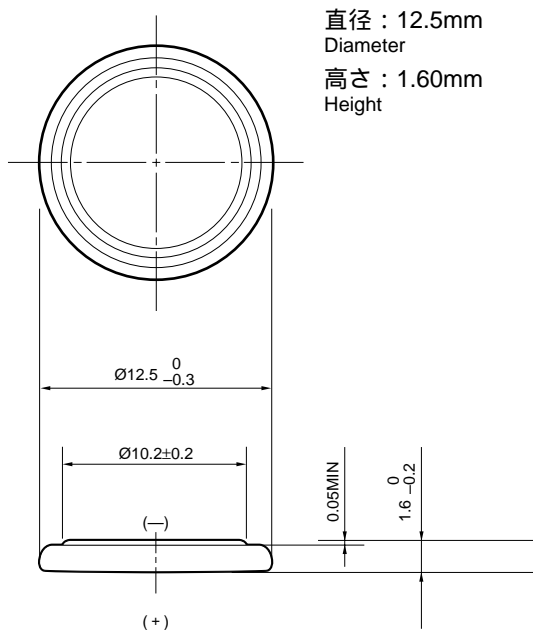

### 定格 Specifications

公称電圧 Nominal Voltage	3V
公称容量 (終止電圧2.5V) Nominal Capacity (2.5V cutoff)	30mAh
推奨負荷電流値 (標準) Recommended Continuous Drain	0.1mA
推奨負荷電流値 (パルス) Recommended Pulse Drain	5mA
標準質量 Weight	0.7g
用途 Applications	
時計 電子手帳・電卓 SRAMやリアルタイムクロック等メモリーバックアップ Electronic Watch or Clock Electronic Calculator Memory Back-up Power Source for SRAM or Real Time Clock (RTC)	

### 放電特性 Discharge Characteristics

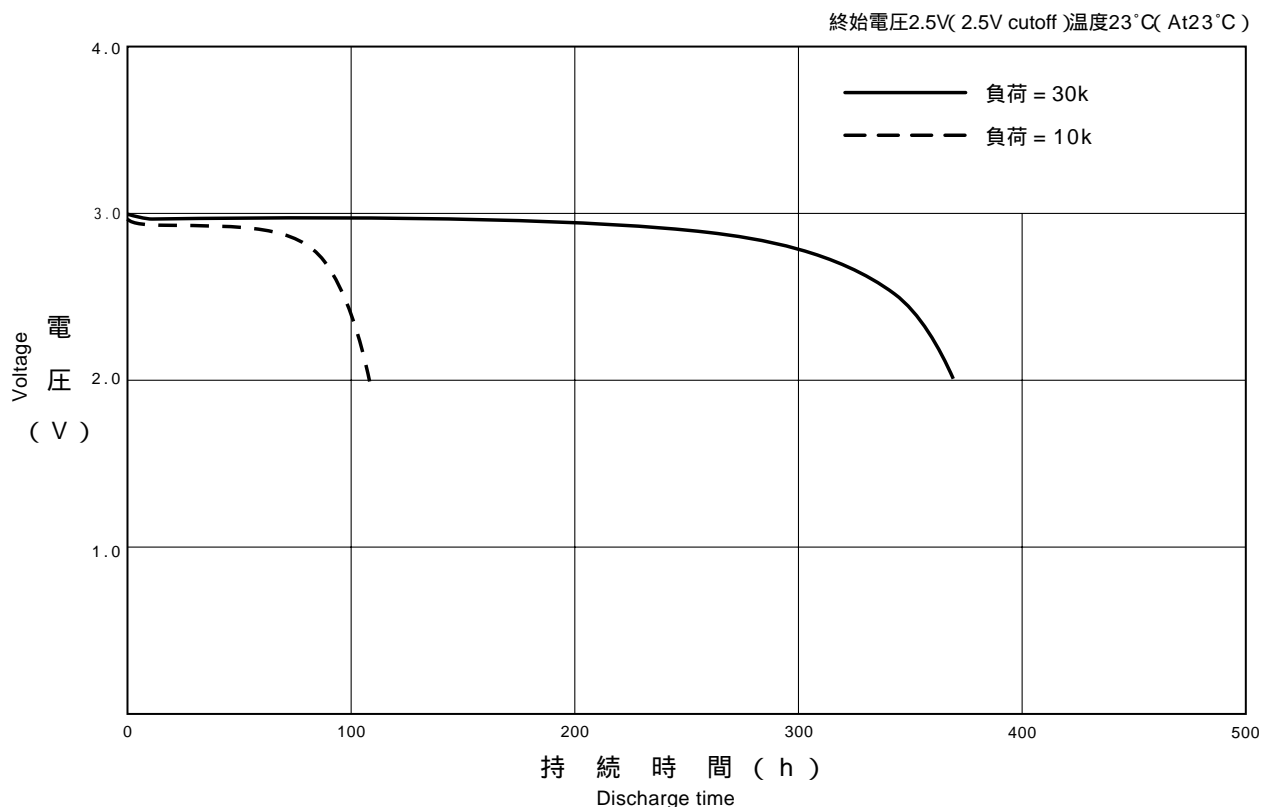

# DATA SHEET

## 放電負荷特性

Discharge Characteristics on Load

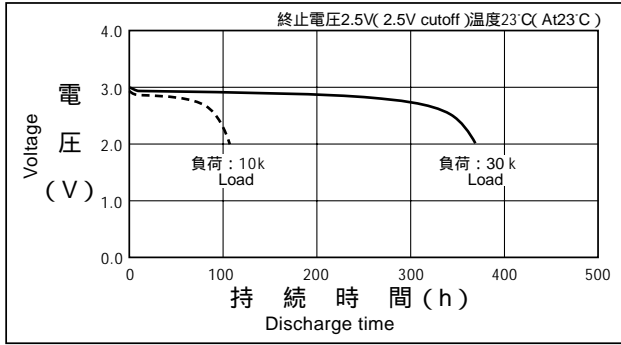

## 放電温度特性

Discharge Characteristics on Temperature

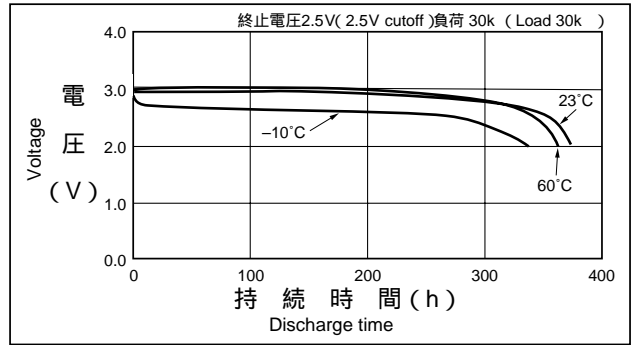

## 放電負荷と作動電圧(放電深度40%時の電圧)

Discharge Load vs. Operation Voltage (Discharge depth 40%)

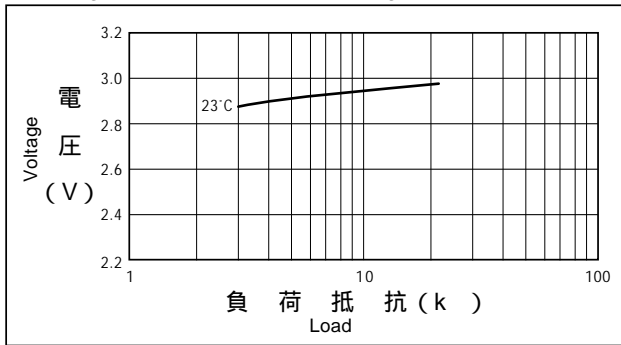

## 放電負荷と電気容量

Discharge Load vs. Discharge Capacity

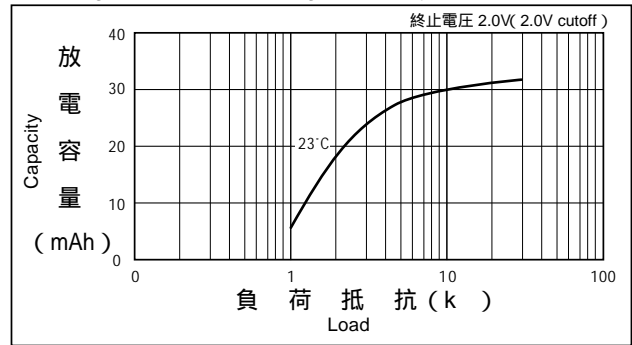

## パルス放電特性(放電深度40%時のパルス電圧)

Discharge Characteristics on Pulse Load (Discharge depth 40%)

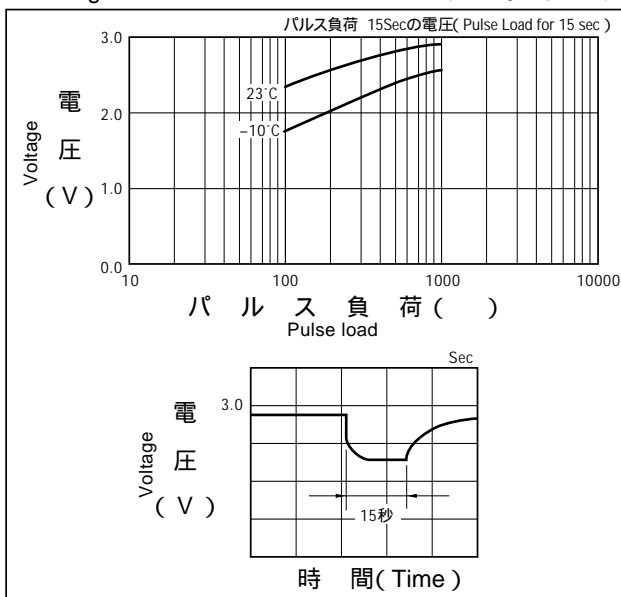

## 保存特性

Storage Characteristics

