

Poly-carbonmonofluoride Lithium Coin Batteries: Individual Specifications

BR1216

■ Dimensions(mm)

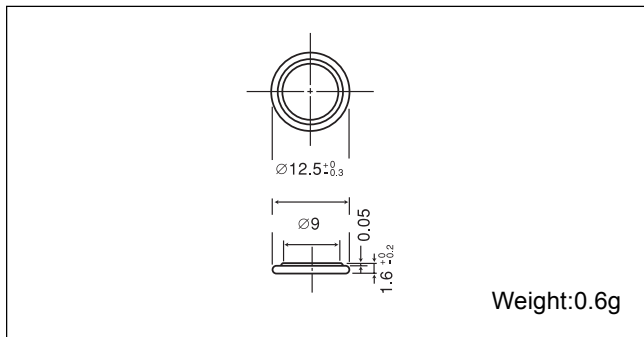

■ Specification

Nominal voltage (V)	3
Nominal capacity (mAh)	25
Continuous standard load (mA)	0.03
Operating temperature (C)	-30 ~ +80

■ Temperature Characteristics

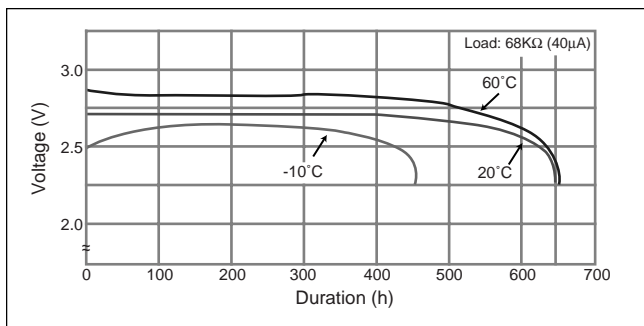

■ Operating voltage vs. load resistance(voltage at 50% discharge depth)

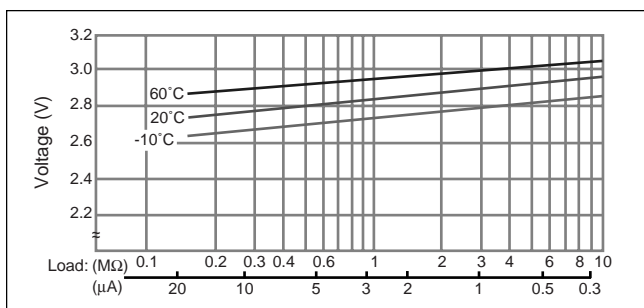

■ Capacity vs. load resistance

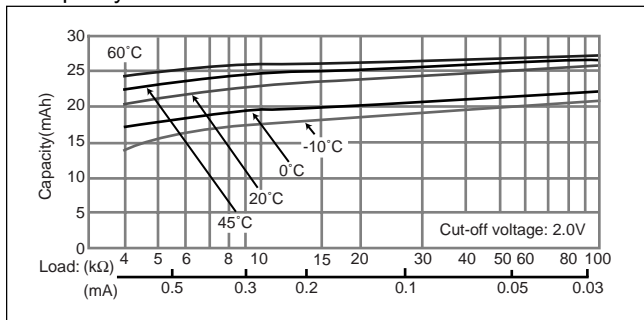

BR1220

■ Dimensions(mm)

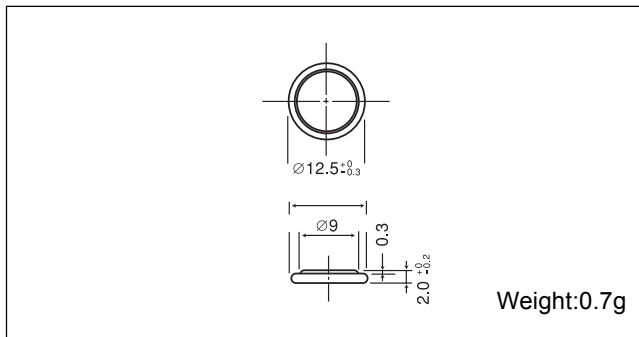

■ Specification

Nominal voltage (V)	3
Nominal capacity (mAh)	35
Continuous standard load (mA)	0.03
Operating temperature (C)	-30 ~ +80

■ Temperature Characteristics

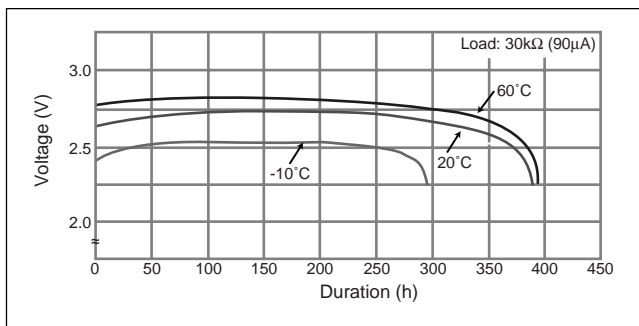

■ Operating voltage vs. load resistance(voltage at 50% discharge depth)

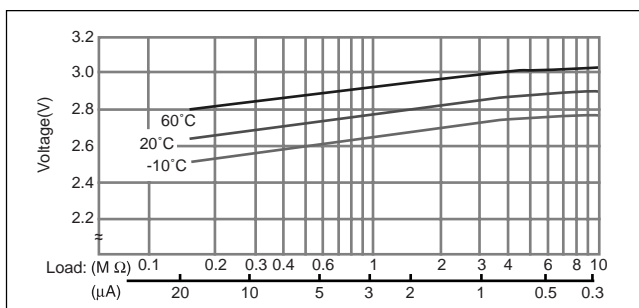

■ Capacity vs. load resistance

