



Manganese Dioxide Lithium Battery

maxell

# CR2450 (610mAh)

# Battery Properties

## ● External Dimensions (unit: mm)

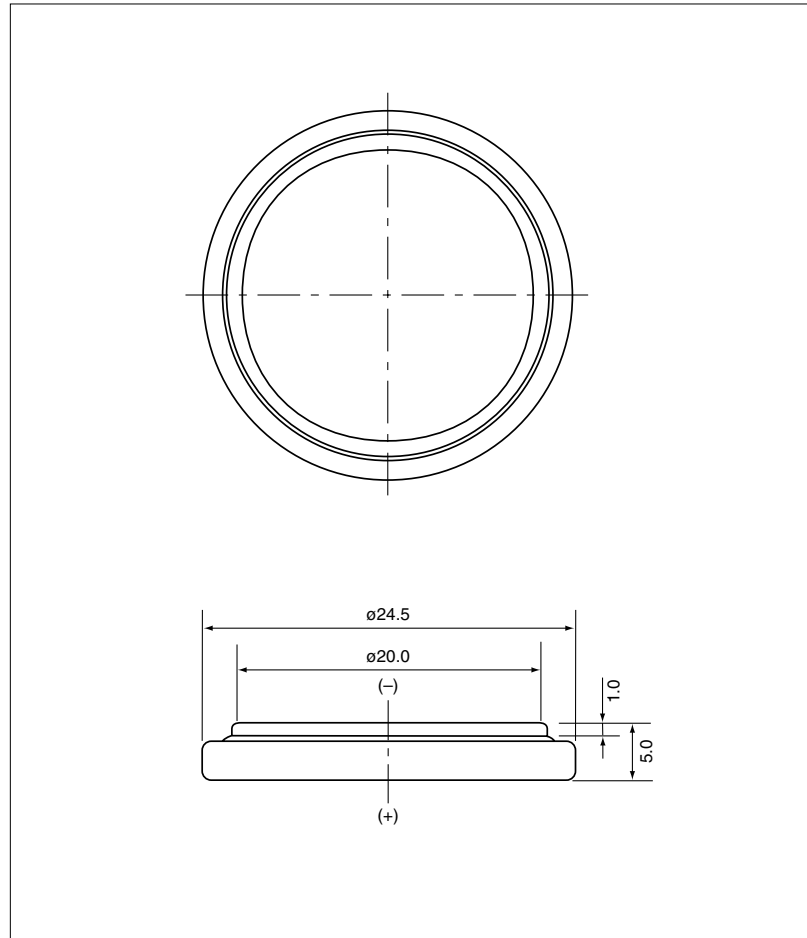

## ● Discharge Characteristics

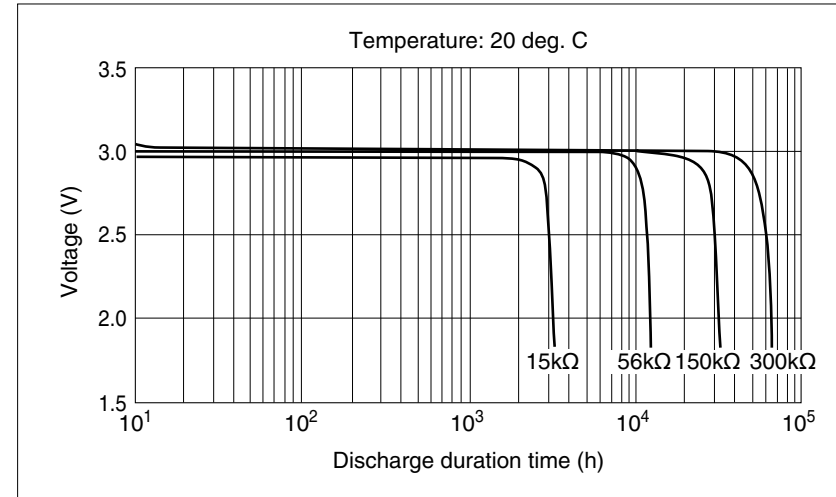

## ● Temperature Characteristics

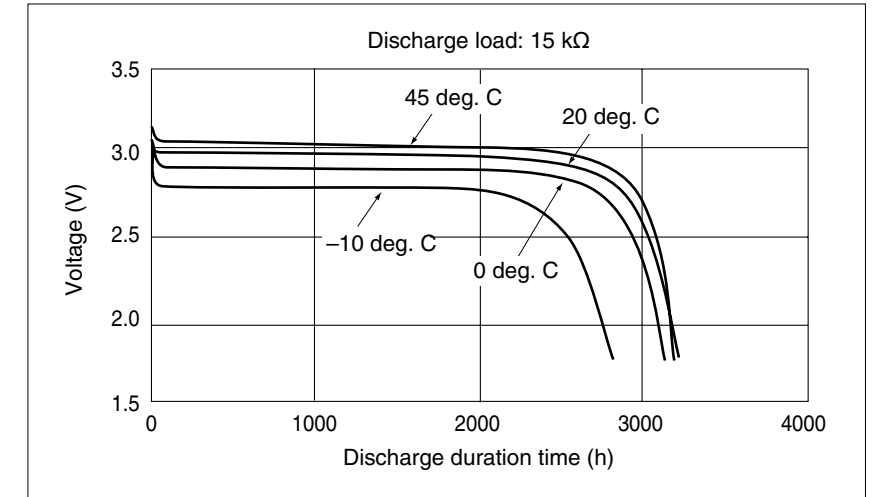

## ● Pulse Discharge Characteristics

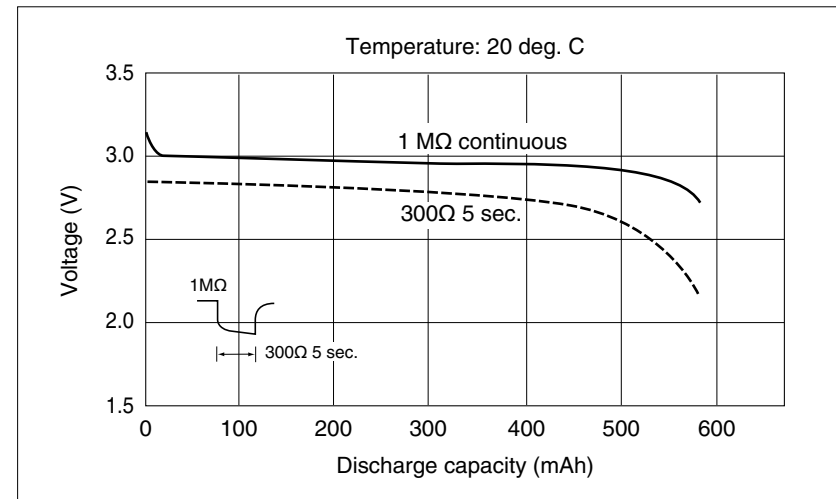

## ● Relationship between Discharge Current and Discharge Capacity

