

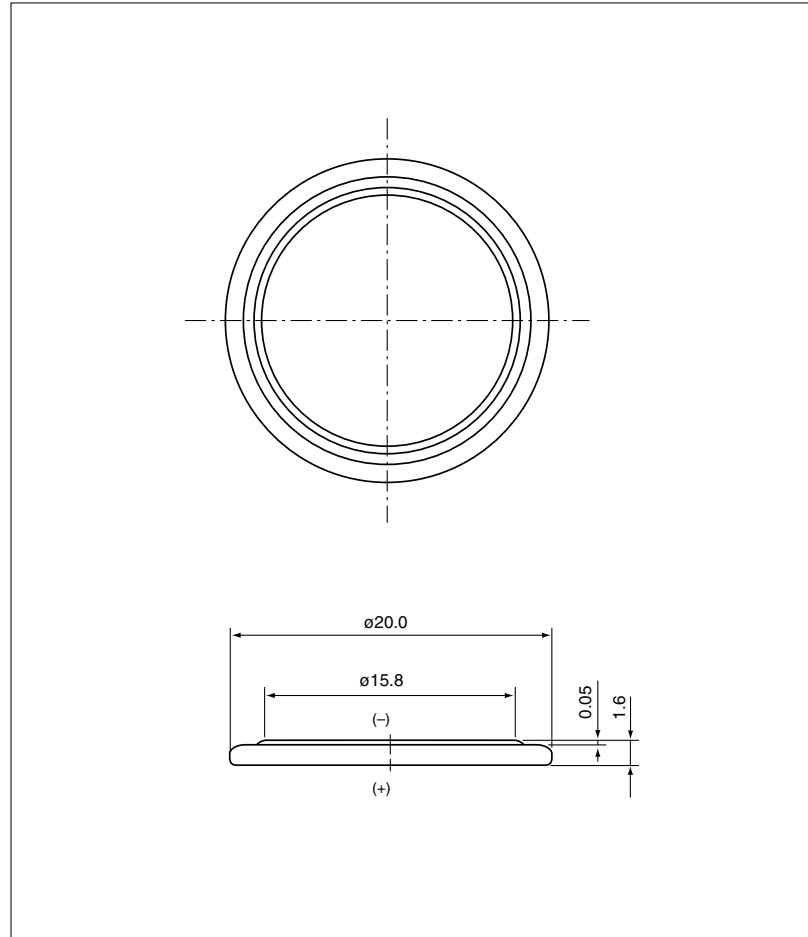

CR2016 (90mAh)

Battery Properties

● External Dimensions (unit: mm)



● Discharge Characteristics

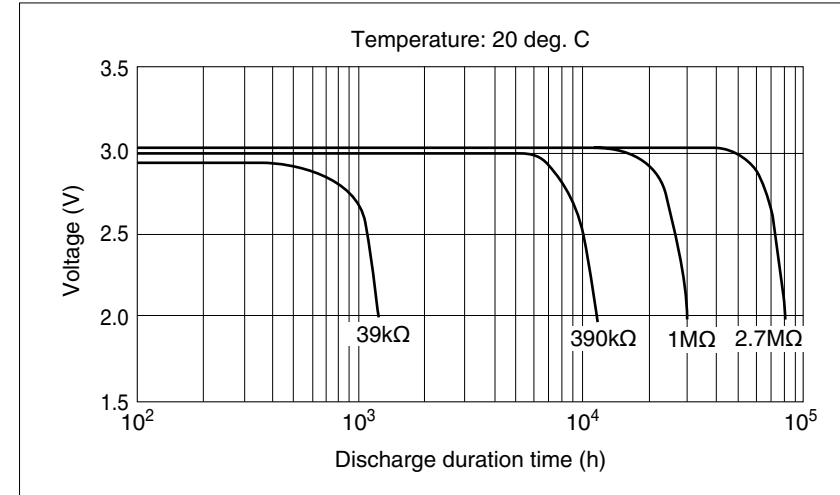

● Temperature Characteristics

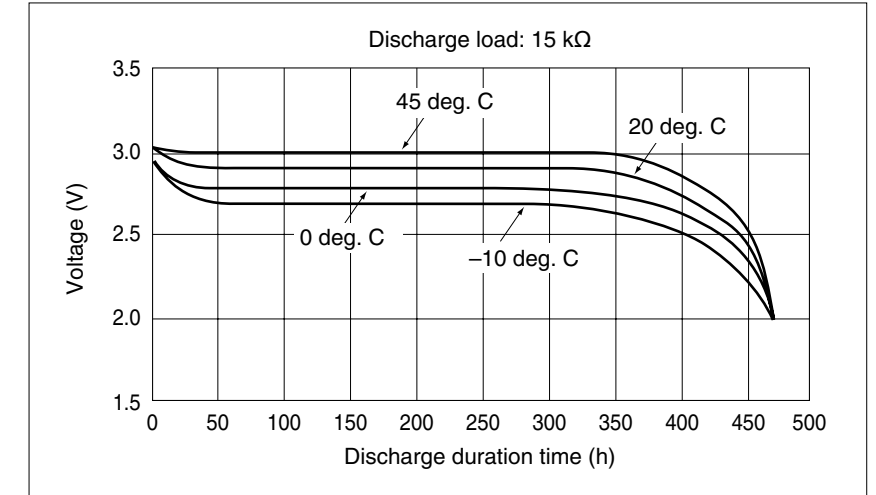

● Pulse Discharge Characteristics

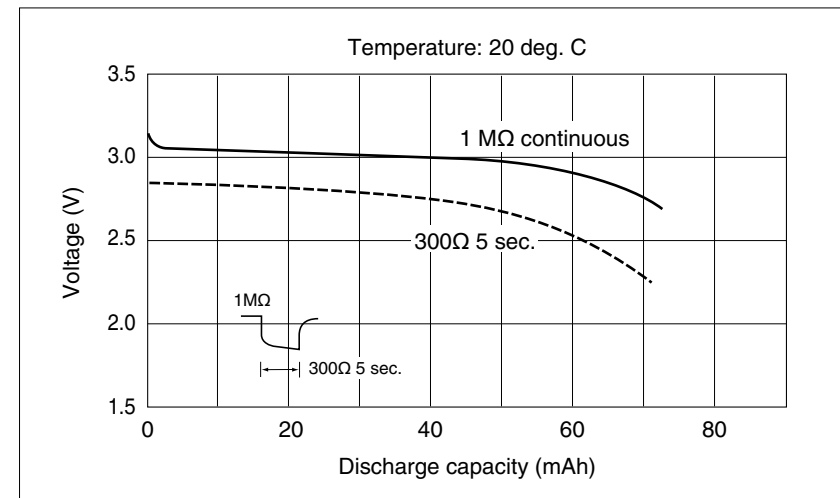

● Relationship between Discharge Current and Discharge Capacity

