

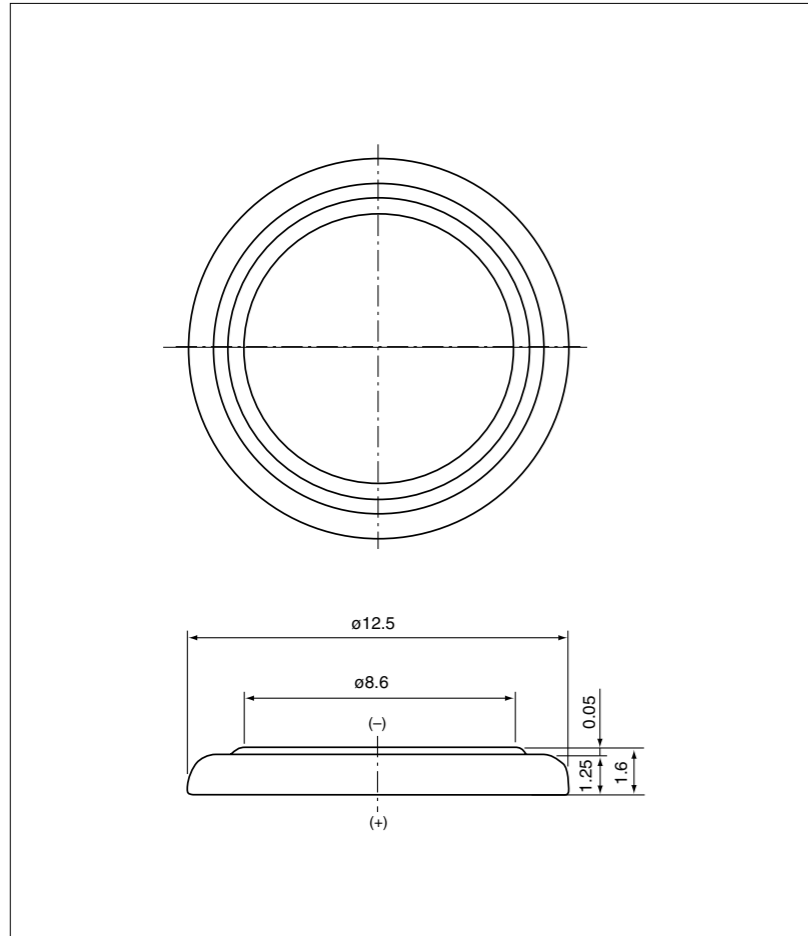

# CR1216 (25mAh)

# Battery Properties

### ● External Dimensions (unit: mm)



### ● Discharge Characteristics

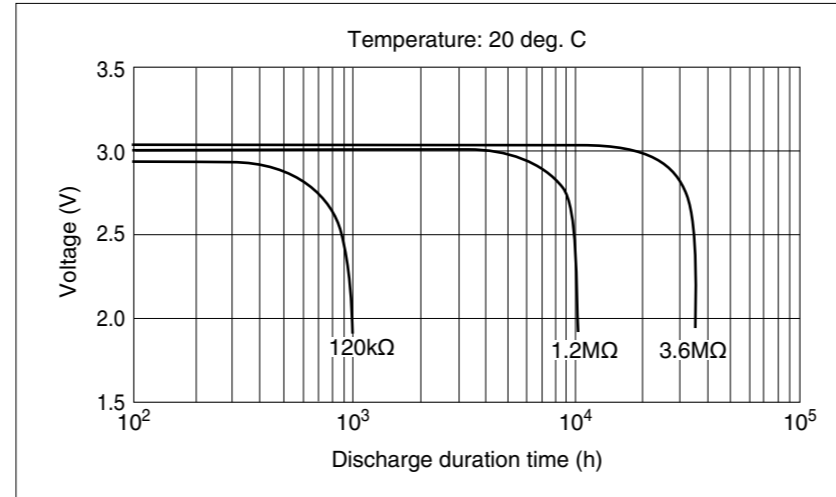

### ● Temperature Characteristics

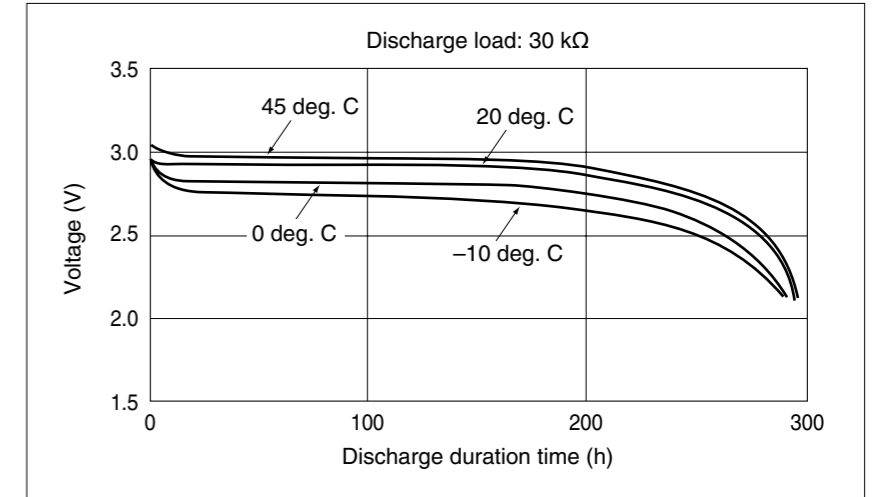

### ● Pulse Discharge Characteristics

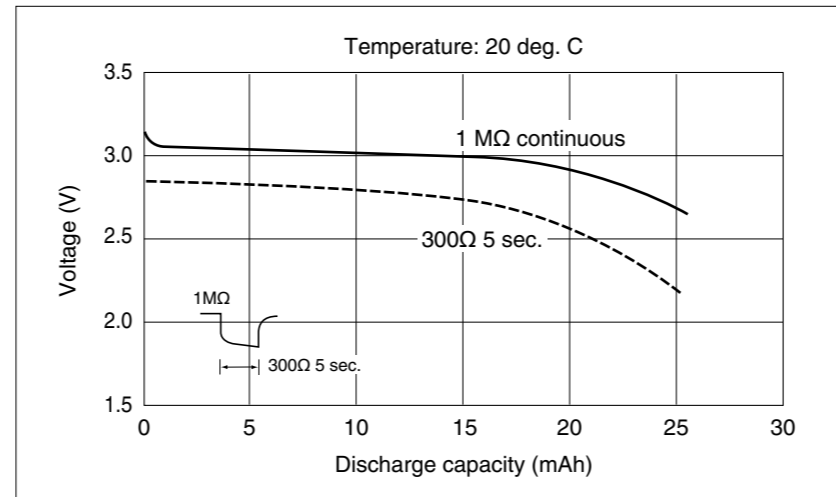

### ● Relationship between Discharge Current and Discharge Capacity

